

BORACAY

- 1 *Specifications*
- 2 *Summary Table*
- 3 *Capacity Table*
- 4 *Dimensional Drawing*
- 5 *Center of Gravity*
- 6 *Electrical Wiring Diagram*
- 7 *Sound data*
- 8 *Temperature and Air Flow Distribution*
- 9 *Piping Diagram*

1. Specification

BORACAY

Type			WALL MOUNTED	WALL MOUNTED	WALL MOUNTED	WALL MOUNTED	
Model CODE			AM015KNTDEH/EU	AM022KNTDEH/EU	AM028KNTDEH/EU	AM036KNTDEH/EU	
Power Supply			Ø, #, V, Hz	1, 2, 220-240, 50	1, 2, 220-240, 50	1, 2, 220-240, 50	
Mode			-	HEAT PUMP	HEAT PUMP	HEAT PUMP	
Performance	Capacity (Nominal)	Cooling	kW	1.5	2.2	2.8	3.6
			Btu/h	5,100	7,500	9,600	12,300
		Heating	kW	1.7	2.5	3.2	4.0
			Btu/h	5,800	8,500	10,900	13,600
Power	Power Input (Nominal)	Cooling	W	32.0	32.0	38.0	42.0
		Heating		34.0	35.0	39.0	42.0
	Current Input (Nominal)	Cooling	A	0.20	0.20	0.22	0.23
		Heating		0.20	0.20	0.22	0.23
	MCA			0.3	0.3	0.4	0.4
MFA			15.0	15.0	15.0	15.0	
Heat exchanger	Type		-	Fin & Tube	Fin & Tube	Fin & Tube	Fin & Tube
	Material	Fin	-	Al	Al	Al	Al
		Tube	-	Cu	Cu	Cu	Cu
	Fin Treatment		-	Anti-corrosion	Anti-corrosion	Anti-corrosion	Anti-corrosion
Fan	Type		-	Crossflow Fan	Crossflow Fan	Crossflow Fan	Crossflow Fan
	Quantity		ea	1	1	1	1
	Air Flow Rate	H/M/L (UL)	CMM	6.2/5.7/5.1	6.6/5.7/5.1	7.0/6.2/5.5	8.5/7.5/6.6
			l/s	103.3/95.0/85.0	110.0/95.0/85.0	116.7/103.3/91.7	141.7/125.0/110.0
	External Pressure	Min/Std/Max	mmAq	-	-	-	-
Pa			-	-	-	-	
Fan motor	Type		-	SSR Feedback	SSR Feedback	SSR Feedback	SSR Feedback
	Output x n		-	19W x 1	19W x 1	19W x 1	19W x 1
Piping Connections	Liquid Pipe		Type	Flare connection	Flare connection	Flare connection	Flare connection
			Ø, mm	6.35	6.35	6.35	6.35
			Ø, inch	1/4"	1/4"	1/4"	1/4"
	Gas Pipe		Type	Flare connection	Flare connection	Flare connection	Flare connection
			Ø, mm	12.7	12.7	12.7	12.7
			Ø, inch	1/2"	1/2"	1/2"	1/2"
	Drain Pipe		Ø, mm	ID 18 HOSE	ID 18 HOSE	ID 18 HOSE	ID 18 HOSE
Heat insulation		-	Both liquid and gas pipes	Both liquid and gas pipes	Both liquid and gas pipes	Both liquid and gas pipes	
Field Wiring	Power Source Wire	Minimum	mm ²	1.5	1.5	1.5	1.5
	For connection with indoor	Minimum	mm ²	0.75	0.75	0.75	0.75
		Remark	-	F1, F2	F1, F2	F1, F2	F1, F2
Refrigerant	Type		-	R410A	R410A	R410A	R410A
	Control Method		-	EEV NOT INCLUDED	EEV NOT INCLUDED	EEV NOT INCLUDED	EEV NOT INCLUDED
Sound	Sound Pressure	High/Mid/Low	dB(A)	30/28/25	31/28/25	31/29/26	36/33/29
	Sound Power	Cooling		47	48	48	51
Dimensions	Net Weight		kg	8.0	8.0	8.5	8.5
	Shipping Weight		kg	9.7	9.7	10.2	10.2
	Net Dimensions (W×H×D)		mm	820 x 285 x 227	820 x 285 x 227	820 x 285 x 227	820 x 285 x 227
	Shipping Dimensions (W×H×D)		mm	880 x 280 x 363	880 x 280 x 363	880 x 280 x 363	880 x 280 x 363

NOTE

- Mode : HP(Heat Pump), HR(Heat Recovery)
- Nominal Cooling : Indoor temperature 27°CDB / 19°CWB, Outdoor temperature 35°CDB / 24°CWB, Refrigerant pipe length 7.5m, Level difference 0m.
- Nominal Heating : Indoor temperature 20°CDB / 15°CWB, Outdoor temperature 7°CDB / 6°CWB, Refrigerant pipe length 7.5m, Level difference 0m.
- Sound level was acquired in an anechoic room. Thus actual noise level may be different depending on the installation conditions.
- These products contain R410A which is fluorinated greenhouse gas.
- Specifications may be subject to change without prior notice.
- Select wire size based on the value of MCA

1. Specification

BORACAY

Type				WALL MOUNTED	WALL MOUNTED	WALL MOUNTED	
Model CODE				AM045KNTDEH/EU	AM056KNTDEH/EU	AM071KNTDEH/EU	
Power Supply			Ø, #, V, Hz	1,2,220-240,50	1,2,220-240,50	1,2,220-240,50	
Mode				HEAT PUMP	HEAT PUMP	HEAT PUMP	
Performance	Capacity (Nominal)	Cooling	kW	4.5	5.6	6.8	
			Btu/h	15,400	19,100	23,200	
		Heating	kW	5.0	6.3	7.0	
			Btu/h	17,100	21,500	23,900	
Power	Power Input (Nominal)	Cooling	W	47.0	48.0	51.0	
		Heating		47.0	48.0	53.0	
	Current Input (Nominal)	Cooling	A	0.27	0.27	0.28	
		Heating		0.27	0.27	0.28	
	MCA			0.4	0.4	0.4	
	MFA			15.0	15.0	15.0	
Heat exchanger				Fin & Tube	Fin & Tube	Fin & Tube	
	Material	Fin		-	Al	Al	Al
		Tube	-	Cu	Cu	Cu	
	Fin Treatment		-	Anti-corrosion	Anti-corrosion	Anti-corrosion	
Fan	Type		-	Crossflow Fan	Crossflow Fan	Crossflow Fan	
	Quantity		ea	1	1	1	
	Air Flow Rate	H/M/L (UL)	CMM	13.9/12.4/11.2	14.4/12.9/11.2	15.7/14.1/12.9	
			l/s	231.7/206.7/186.7	240.0/215.0/186.7	261.7/235.0/215.0	
	External Pressure	Min/Std/Max	mmAq	-	-	-	
			Pa	-	-	-	
Fan motor	Type		-	SSR Feedback	SSR Feedback	SSR Feedback	
	Output x n		-	28W x 1	28W x 1	28W x 1	
Piping Connections	Liquid Pipe		Type	Flare connection	Flare connection	Flare connection	
			Ø, mm	6.35	6.35	9.52	
			Ø, inch	1/4"	1/4"	3/8"	
	Gas Pipe		Type	Flare connection	Flare connection	Flare connection	
			Ø, mm	12.7	12.7	15.88	
			Ø, inch	1/2"	1/2"	5/8"	
Drain Pipe		Ø, mm	ID 18 HOSE	ID 18 HOSE	ID 18 HOSE		
Heat insulation		-	Both liquid and gas pipes	Both liquid and gas pipes	Both liquid and gas pipes		
Field Wiring	Power Source Wire	Minimum	mm2	1.5	1.5	1.5	
		For connection with indoor	Minimum	mm2	0.75	0.75	0.75
			Remark	-	F1, F2	F1, F2	F1, F2
Refrigerant	Type		-	R410A	R410A	R410A	
	Control Method		-	EEV NOT INCLUDED	EEV NOT INCLUDED	EEV NOT INCLUDED	
Sound	Sound Pressure	High/Mid/Low	dB(A)	38/35/33	39/36/33	40/38/35	
	Sound Power	Cooling		53	53	55	
Dimensions	Net Weight		kg	12.0	12.0	12.0	
	Shipping Weight		kg	14.0	14.0	14.0	
	Net Dimensions (W×H×D)		mm	1065 x 298 x 243	1065 x 298 x 243	1065 x 298 x 243	
	Shipping Dimensions (W×H×D)		mm	1128 x 299 x 378	1128 x 299 x 378	1128 x 299 x 378	

NOTE

- Mode : HP(Heat Pump), HR(Heat Recovery)
- Nominal Cooling : Indoor temperature 27°CDB / 19°CWB, Outdoor temperature 35°CDB / 24°CWB, Refrigerant pipe length 7.5m, Level difference 0m.
- Nominal Heating : Indoor temperature 20°CDB / 15°CWB, Outdoor temperature 7°CDB / 6°CWB, Refrigerant pipe length 7.5m, Level difference 0m.
- Sound level was acquired in an anechoic room. Thus actual noise level may be different depending on the installation conditions.
- These products contain R410A which is fluorinated greenhouse gas.
- Specifications may be subject to change without prior notice.
- Select wire size based on the value of MCA

1. Specification

BORACAY

Type			WALL MOUNTED	WALL MOUNTED	WALL MOUNTED	WALL MOUNTED	
Model CODE			AM015KNQDEH/EU	AM022KNQDEH/EU	AM028KNQDEH/EU	AM036KNQDEH/EU	
Power Supply		Ø, #, V, Hz	1,2,220-240,50	1,2,220-240,50	1,2,220-240,50	1,2,220-240,50	
Mode			HEAT PUMP	HEAT PUMP	HEAT PUMP	HEAT PUMP	
Performance	Capacity (Nominal)	Cooling	kW	1.5	2.2	2.8	3.6
			Btu/h	5,100	7,500	9,600	12,300
		Heating	kW	1.7	2.5	3.2	4.0
			Btu/h	5,800	8,500	10,900	13,600
Power	Power Input (Nominal)	Cooling	W	32.0	32.0	38.0	42.0
		Heating		34.0	35.0	39.0	42.0
	Current Input (Nominal)	Cooling	A	0.20	0.20	0.22	0.23
		Heating		0.20	0.20	0.22	0.23
	MCA			0.3	0.3	0.4	0.4
	MFA			15.0	15.0	15.0	15.0
Type		-		Fin & Tube	Fin & Tube	Fin & Tube	Fin & Tube
Heat exchanger	Material	Fin		-	Al	Al	Al
		Tube	-	Cu	Cu	Cu	Cu
	Fin Treatment		-	Anti-corrosion	Anti-corrosion	Anti-corrosion	Anti-corrosion
Fan	Type		-	Crossflow Fan	Crossflow Fan	Crossflow Fan	Crossflow Fan
	Quantity		ea	1	1	1	1
	Air Flow Rate	H/M/L (UL)	CMM	6.2/5.7/5.1	6.6/5.7/5.1	7.0/6.2/5.5	8.5/7.5/6.6
			l/s	103.3/95.0/85.0	110.0/95.0/85.0	116.7/103.3/91.7	141.7/125.0/110.0
	External Pressure	Min/Std/Max	mmAq	-	-	-	-
			Pa	-	-	-	-
Fan motor	Type		-	SSR Feedback	SSR Feedback	SSR Feedback	SSR Feedback
	Output x n		-	19W x 1	19W x 1	19W x 1	19W x 1
Piping Connections	Liquid Pipe		Type	Flare connection	Flare connection	Flare connection	Flare connection
			Ø, mm	6.35	6.35	6.35	6.35
			Ø, inch	1/4"	1/4"	1/4"	1/4"
	Gas Pipe		Type	Flare connection	Flare connection	Flare connection	Flare connection
			Ø, mm	12.7	12.7	12.7	12.7
			Ø, inch	1/2"	1/2"	1/2"	1/2"
	Drain Pipe		Ø, mm	ID 18 HOSE	ID 18 HOSE	ID 18 HOSE	ID 18 HOSE
Heat insulation		-	Both liquid and gas pipes	Both liquid and gas pipes	Both liquid and gas pipes	Both liquid and gas pipes	
Field Wiring	Power Source Wire	Minimum	mm2	1.5	1.5	1.5	1.5
	For connection with indoor	Minimum	mm2	0.75	0.75	0.75	0.75
		Remark	-	F1, F2	F1, F2	F1, F2	F1, F2
Refrigerant	Type		-	R410A	R410A	R410A	R410A
	Control Method		-	EEV INCLUDED	EEV INCLUDED	EEV INCLUDED	EEV INCLUDED
Sound	Sound Pressure	High/Mid/Low	dB(A)	30/28/25	31/28/25	31/29/26	36/33/29
	Sound Power	Cooling		47	48	48	51
Dimensions	Net Weight		kg	8.5	8.5	9.0	9.0
	Shipping Weight		kg	10.2	10.2	10.6	10.6
	Net Dimensions (W×H×D)		mm	820 x 285 x 227	820 x 285 x 227	820 x 285 x 227	820 x 285 x 227
	Shipping Dimensions (W×H×D)		mm	880 x 280 x 363	880 x 280 x 363	880 x 280 x 363	880 x 280 x 363

NOTE

- Mode : HP(Heat Pump), HR(Heat Recovery)
- Nominal Cooling : Indoor temperature 27°CDB / 19°CWB, Outdoor temperature 35°CDB / 24°CWB, Refrigerant pipe length 7.5m, Level difference 0m.
- Nominal Heating : Indoor temperature 20°CDB / 15°CWB, Outdoor temperature 7°CDB / 6°CWB, Refrigerant pipe length 7.5m, Level difference 0m.
- Sound level was acquired in an anechoic room. Thus actual noise level may be different depending on the installation conditions.
- These products contain R410A which is fluorinated greenhouse gas.
- Specifications may be subject to change without prior notice.
- Select wire size based on the value of MCA

1. Specification

BORACAY

Type				WALL MOUNTED	WALL MOUNTED	WALL MOUNTED	
Model CODE				AM045KNQDEH/EU	AM056KNQDEH/EU	AM071KNQDEH/EU	
Power Supply			Ø, #, V, Hz	1,2,220-240,50	1,2,220-240,50	1,2,220-240,50	
Mode				HEAT PUMP	HEAT PUMP	HEAT PUMP	
Performance	Capacity (Nominal)	Cooling	kW	4.5	5.6	6.8	
			Btu/h	15,400	19,100	23,200	
		Heating	kW	5.0	6.3	7.0	
			Btu/h	17,100	21,500	23,900	
Power	Power Input (Nominal)	Cooling	W	47.0	48.0	51.0	
		Heating		47.0	48.0	53.0	
	Current Input (Nominal)	Cooling	A	0.27	0.27	0.28	
		Heating		0.27	0.27	0.28	
	MCA	0.4		0.4	0.4		
	MFA	15.0		15.0	15.0		
Heat exchanger	Type			-	Fin & Tube	Fin & Tube	Fin & Tube
	Material	Fin		-	Al	Al	Al
		Tube	-	Cu	Cu	Cu	
	Fin Treatment		-	Anti-corrosion	Anti-corrosion	Anti-corrosion	
Fan	Type		-	Crossflow Fan	Crossflow Fan	Crossflow Fan	
	Quantity		ea	1	1	1	
	Air Flow Rate	H/M/L (UL)	CMM	13.9/12.4/11.2	14.4/12.9/11.2	15.7/14.1/12.9	
			l/s	231.7/206.7/186.7	240.0/215.0/186.7	261.7/235.0/215.0	
	External Pressure	Min/Std/Max	mmAq	-	-	-	
			Pa	-	-	-	
Fan motor	Type		-	SSR Feedback	SSR Feedback	SSR Feedback	
	Output x n		-	28W x 1	28W x 1	28W x 1	
Piping Connections	Liquid Pipe		Type	Flare connection	Flare connection	Flare connection	
			Ø, mm	6.35	6.35	9.52	
			Ø, inch	1/4"	1/4"	3/8"	
	Gas Pipe		Type	Flare connection	Flare connection	Flare connection	
			Ø, mm	12.7	12.7	15.88	
			Ø, inch	1/2"	1/2"	5/8"	
Drain Pipe		Ø, mm	ID 18 HOSE	ID 18 HOSE	ID 18 HOSE		
Heat insulation		-	Both liquid and gas pipes	Both liquid and gas pipes	Both liquid and gas pipes		
Field Wiring	Power Source Wire	Minimum	mm2	1.5	1.5	1.5	
		For connection with indoor	Minimum	mm2	0.75	0.75	0.75
			Remark	-	F1, F2	F1, F2	
Refrigerant	Type		-	R410A	R410A	R410A	
	Control Method		-	EEV INCLUDED	EEV INCLUDED	EEV INCLUDED	
Sound	Sound Pressure	High/Mid/Low	dB(A)	38/35/33	39/36/33	40/38/35	
	Sound Power	Cooling		53	53	55	
Dimensions	Net Weight		kg	12.5	12.5	12.5	
	Shipping Weight		kg	14.5	14.5	14.5	
	Net Dimensions (W×H×D)		mm	1065 x 298 x 243	1065 x 298 x 243	1065 x 298 x 243	
	Shipping Dimensions (W×H×D)		mm	1128 x 299 x 378	1128 x 299 x 378	1128 x 299 x 378	

NOTE

- Mode : HP(Heat Pump), HR(Heat Recovery)
- Nominal Cooling : Indoor temperature 27°CDB / 19°CWB, Outdoor temperature 35°CDB / 24°CWB, Refrigerant pipe length 7.5m, Level difference 0m.
- Nominal Heating : Indoor temperature 20°CDB / 15°CWB, Outdoor temperature 7°CDB / 6°CWB, Refrigerant pipe length 7.5m, Level difference 0m.
- Sound level was acquired in an anechoic room. Thus actual noise level may be different depending on the installation conditions.
- These products contain R410A which is fluorinated greenhouse gas.
- Specifications may be subject to change without prior notice.
- Select wire size based on the value of MCA

2. Summary Table

BORACAY

Performance Characteristics

Model Code	Net Weight (kg)	Fan Speed	Nominal Capacity			Airflow (CMM)	Sound Pressure (dBA)	Sound Power (dBA)
			Cooling (kW)	Sensible (Kw)	Heating (kW)			
AM015KNTDEH/EU (AM015KNQDEH/EU)	8.0 (8.5)	High	1.5	1.0	1.7	6.2	30	47
		Mid	1.2	0.9	1.6	5.7	28	-
		Low	1.0	0.8	1.5	5.1	25	-
AM022KNTDEH/EU (AM022KNQDEH/EU)	8.0 (8.5)	High	2.2	1.5	2.5	6.6	31	48
		Mid	1.6	1.4	2.3	5.7	28	-
		Low	1.3	1.2	2.2	5.1	25	-
AM028KNTDEH/EU (AM028KNQDEH/EU)	8.5 (9.0)	High	2.8	1.9	3.2	7.0	31	48
		Mid	2.1	1.7	3.0	6.2	29	-
		Low	1.7	1.5	2.8	5.5	26	-
AM036KNTDEH/EU (AM036KNQDEH/EU)	8.5 (9.0)	High	3.6	2.4	4.0	8.5	36	51
		Mid	2.6	2.2	3.8	7.5	33	-
		Low	2.1	1.8	3.5	6.6	29	-
AM045KNTDEH/EU (AM045KNQDEH/EU)	12.0 (12.5)	High	4.5	3.1	5.0	13.9	38	53
		Mid	3.2	2.7	4.7	12.4	35	-
		Low	2.6	2.1	4.5	11.2	33	-
AM056KNTDEH/EU (AM056KNQDEH/EU)	12.0 (12.5)	High	5.6	3.8	6.3	14.4	39	53
		Mid	4.0	3.3	6.0	12.9	36	-
		Low	3.1	2.7	5.6	11.2	33	-
AM071KNTDEH/EU (AM071KNQDEH/EU)	12.0 (12.5)	High	6.8	4.6	7.0	15.7	40	55
		Mid	4.7	4.0	6.6	14.1	38	-
		Low	3.7	2.9	6.3	12.9	35	-

Electrical Characteristics

Model Code	Power Supply (Ø, #, V, Hz)	Power Input (W) (C / H)	Current Input (A) (C / H)	MCA (A)	MFA (A)	FLA (A)
AM015KN*DEH/EU	1Ø/220~240V/50Hz	32/34	0.20/0.20	0.3	15	0.22
AM022KN*DEH/EU	1Ø/220~240V/50Hz	32/35	0.20/0.20	0.3	15	0.22
AM028KN*DEH/EU	1Ø/220~240V/50Hz	38/39	0.22/0.22	0.4	15	0.25
AM036KN*DEH/EU	1Ø/220~240V/50Hz	42/42	0.23/0.23	0.4	15	0.25
AM045KN*DEH/EU	1Ø/220~240V/50Hz	47/47	0.27/0.27	0.4	15	0.30
AM056KN*DEH/EU	1Ø/220~240V/50Hz	48/48	0.27/0.27	0.4	15	0.30
AM071KN*DEH/EU	1Ø/220~240V/50Hz	51/53	0.28/0.28	0.4	15	0.30

NOTE

- MCA : Minimum circuit amperes
- MFA : Maximum fuse amperes
- Select wire size based on the value of MCA

3. Capacity Table

BORACAY

Heating

TC: Total Capacity

Model	Outdoor temperature (°C)		Indoor temperature (°C, WB)				
			16.0	18.0	20.0	22.0	24.0
	DB	WB	TC	TC	TC	TC	TC
1.50	-20	-21	1.00	1.00	1.00	1.00	0.90
	-17	-18	1.00	1.00	1.00	1.00	0.90
	-15	-16	1.10	1.10	1.00	1.00	0.90
	-12	-13	1.10	1.10	1.10	1.10	1.00
	-10	-11	1.20	1.20	1.20	1.20	1.10
	-7	-8	1.30	1.30	1.30	1.30	1.20
	-5	-6	1.40	1.40	1.30	1.30	1.20
	-3	-4	1.40	1.40	1.40	1.30	1.30
	0	-1	1.50	1.50	1.50	1.40	1.40
	3	2	1.50	1.50	1.50	1.40	1.40
	5	4	1.60	1.60	1.60	1.50	1.40
	7	6	1.70	1.70	1.70	1.60	1.40
	9	8	1.80	1.70	1.70	1.60	1.40
	11	10	1.80	1.70	1.70	1.60	1.40
2.20	13	12	2.00	1.80	1.70	1.60	1.40
	15	14	2.10	1.80	1.70	1.60	1.40
	-20	-21	1.50	1.50	1.50	1.50	1.50
	-17	-18	1.60	1.60	1.60	1.60	1.60
	-15	-16	1.70	1.60	1.60	1.60	1.60
	-12	-13	1.80	1.80	1.80	1.80	1.70
	-10	-11	2.00	2.00	1.90	1.90	1.90
	-7	-8	2.30	2.20	2.20	2.00	2.00
	-5	-6	2.40	2.30	2.30	2.20	2.20
	-3	-4	2.50	2.50	2.40	2.30	2.20
	0	-1	2.60	2.50	2.50	2.30	2.20
	3	2	2.70	2.60	2.50	2.30	2.20
	5	4	2.80	2.70	2.50	2.30	2.20
	7	6	2.80	2.70	2.50	2.30	2.20
9	8	3.00	2.70	2.50	2.30	2.20	
11	10	3.00	2.70	2.50	2.30	2.20	
2.80	13	12	3.00	2.70	2.50	2.30	2.20
	15	14	3.00	2.70	2.50	2.30	2.20
	-20	-21	1.90	1.90	1.90	1.90	1.90
	-17	-18	2.00	2.00	2.00	2.00	1.90
	-15	-16	2.10	2.10	2.00	2.00	1.90
	-12	-13	2.20	2.20	2.20	2.10	2.10
	-10	-11	2.30	2.30	2.30	2.30	2.20
	-7	-8	2.50	2.40	2.40	2.40	2.30
	-5	-6	2.60	2.60	2.50	2.50	2.40
	-3	-4	2.80	2.70	2.70	2.60	2.50
	0	-1	2.90	2.80	2.80	2.70	2.60
	3	2	3.00	3.00	2.90	2.80	2.70
	5	4	3.20	3.10	3.10	2.90	2.70
	7	6	3.30	3.20	3.20	3.00	2.70
9	8	3.40	3.30	3.20	3.00	2.70	
11	10	3.50	3.30	3.20	3.00	2.70	
3.60	13	12	3.60	3.40	3.20	3.00	2.70
	15	14	3.70	3.40	3.20	3.00	2.70
	-20	-21	2.40	2.40	2.30	2.30	2.30
	-17	-18	2.60	2.50	2.40	2.40	2.30
	-15	-16	2.70	2.60	2.50	2.50	2.40
	-12	-13	2.80	2.70	2.70	2.60	2.60
-10	-11	2.90	2.90	2.90	2.80	2.80	
-7	-8	3.10	3.10	3.00	3.00	2.90	
-5	-6	3.30	3.20	3.20	3.10	3.00	

3. Capacity Table

Model	Outdoor temperature (°C)		Indoor temperature (°C, WB)				
			16.0	18.0	20.0	22.0	24.0
	DB	WB	TC	TC	TC	TC	TC
			kW	kW	kW	kW	kW
3.60	-3	-4	3.40	3.40	3.30	3.20	3.10
	0	-1	3.60	3.60	3.50	3.40	3.20
	3	2	3.80	3.70	3.70	3.50	3.40
	5	4	3.90	3.90	3.80	3.60	3.40
	7	6	4.10	4.10	4.00	3.70	3.40
	9	8	4.20	4.10	4.00	3.70	3.40
	11	10	4.40	4.20	4.00	3.70	3.40
	13	12	4.50	4.20	4.00	3.70	3.40
4.50	15	14	4.60	4.30	4.00	3.70	3.40
	-20	-21	3.10	3.02	3.02	2.94	2.94
	-17	-18	3.17	3.17	3.10	3.02	3.02
	-15	-16	3.33	3.25	3.17	3.10	3.02
	-12	-13	3.49	3.41	3.33	3.33	3.25
	-10	-11	3.65	3.65	3.57	3.49	3.49
	-7	-8	3.89	3.81	3.81	3.73	3.57
	-5	-6	4.13	4.05	3.97	3.89	3.73
	-3	-4	4.29	4.21	4.21	4.05	3.89
	0	-1	4.52	4.44	4.37	4.21	3.97
	3	2	4.68	4.68	4.60	4.44	4.21
	5	4	4.92	4.84	4.76	4.52	4.21
	7	6	5.16	5.08	5.00	4.60	4.21
	9	8	5.32	5.16	5.00	4.60	4.21
	11	10	5.48	5.24	5.00	4.60	4.21
13	12	5.63	5.32	5.00	4.60	4.21	
15	14	5.79	5.40	5.00	4.60	4.21	
5.60	-20	-21	3.90	3.80	3.80	3.70	3.70
	-17	-18	4.00	4.00	3.90	3.80	3.80
	-15	-16	4.20	4.10	4.00	3.90	3.80
	-12	-13	4.40	4.30	4.20	4.20	4.10
	-10	-11	4.60	4.60	4.50	4.40	4.40
	-7	-8	4.90	4.80	4.80	4.70	4.50
	-5	-6	5.20	5.10	5.00	4.90	4.70
	-3	-4	5.40	5.30	5.30	5.10	4.90
	0	-1	5.70	5.60	5.50	5.30	5.00
	3	2	5.90	5.90	5.80	5.60	5.30
	5	4	6.20	6.10	6.00	5.70	5.30
	7	6	6.50	6.40	6.30	5.80	5.30
	9	8	6.70	6.50	6.30	5.80	5.30
	11	10	6.90	6.60	6.30	5.80	5.30
	13	12	7.10	6.70	6.30	5.80	5.30
15	14	7.30	6.80	6.30	5.80	5.30	
7.10	-20	-21	4.40	4.30	4.20	4.20	4.20
	-17	-18	4.50	4.40	4.30	4.30	4.20
	-15	-16	4.70	4.60	4.40	4.30	4.20
	-12	-13	4.90	4.80	4.70	4.60	4.50
	-10	-11	5.10	5.10	5.00	4.90	4.90
	-7	-8	5.40	5.40	5.30	5.20	5.10
	-5	-6	5.70	5.60	5.60	5.40	5.20
	-3	-4	6.00	5.90	5.90	5.60	5.40
	0	-1	6.30	6.20	6.10	5.90	5.60
	3	2	6.60	6.50	6.40	6.20	5.90
	5	4	6.90	6.80	6.70	6.30	5.90
	7	6	7.20	7.10	7.00	6.50	5.90
	9	8	7.40	7.20	7.00	6.50	5.90
	11	10	7.60	7.30	7.00	6.50	5.90
	13	12	7.90	7.40	7.00	6.50	5.90
15	14	8.10	7.50	7.00	6.50	5.90	

4. Dimensional Drawing

BORACAY

AM015/022/028/036KN*D*****

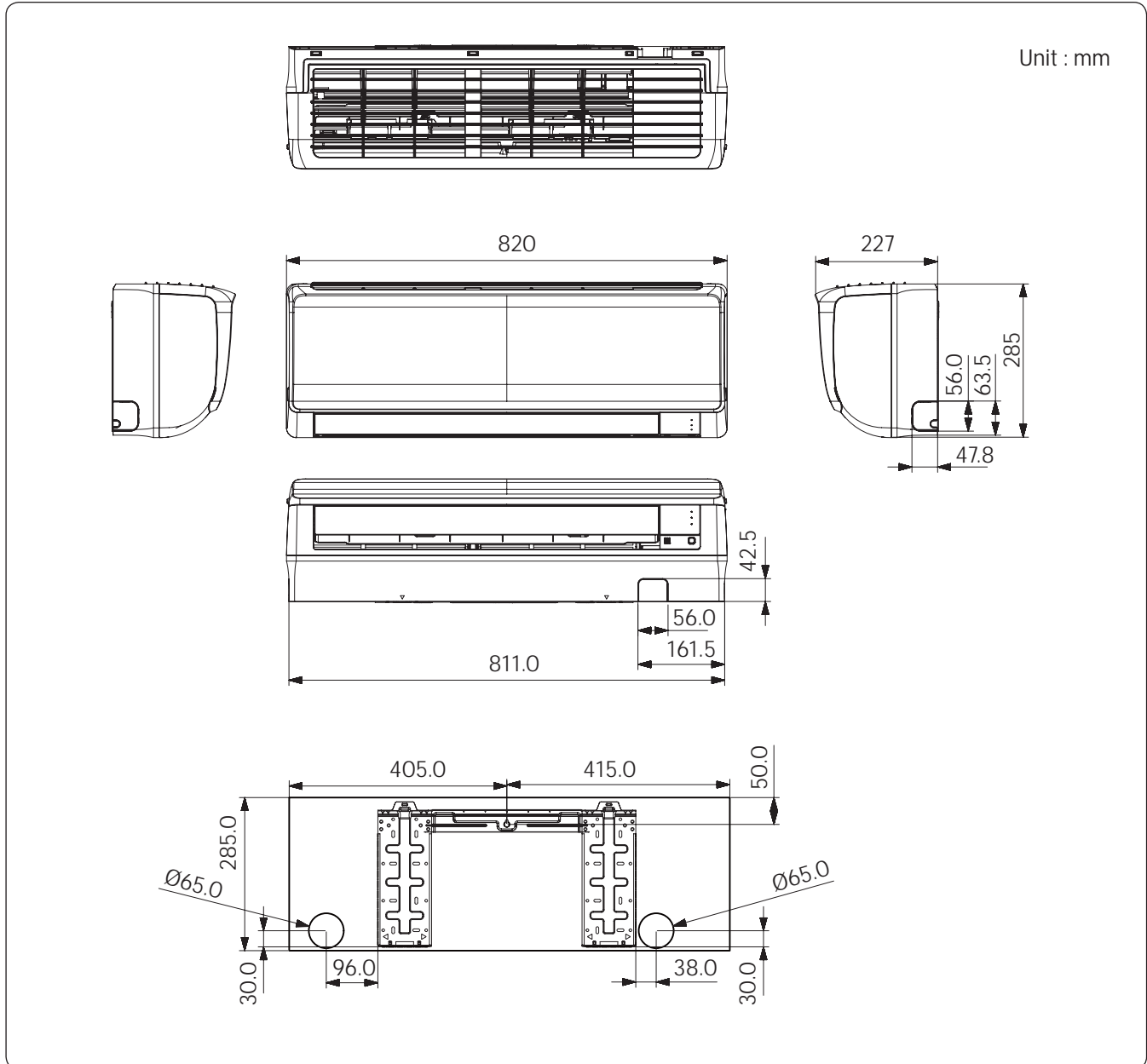

No.	Name	Description
1	Liquid pipe connection	Ø6.35 (Ø1/4)
2	Gas pipe connection	Ø12.7 (Ø1/2)
3	Drain pipe connection	ID 18 HOSE
4	Power & Communication wiring conduit	

5. Center of Gravity

BORACAY

AM015/022/028/036KN*D*****

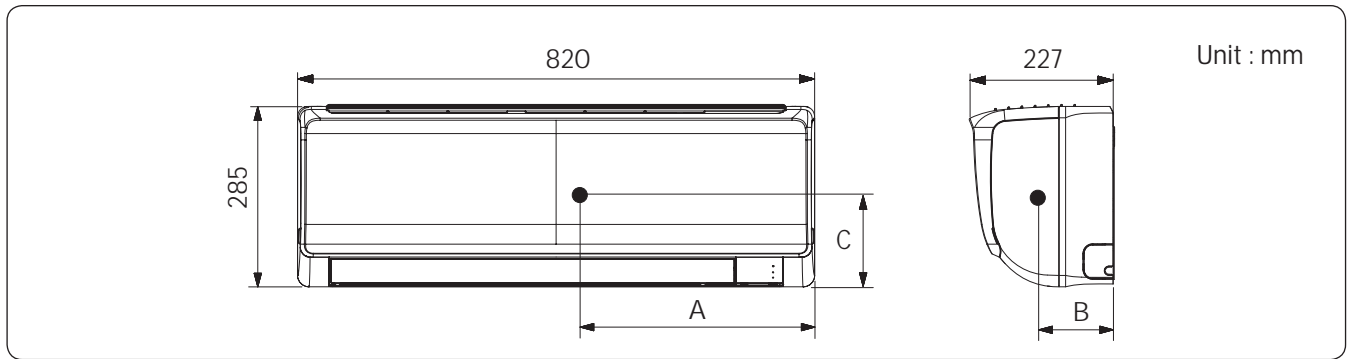

A	B	C
375	105	155

AM045/056/071KN*D*****

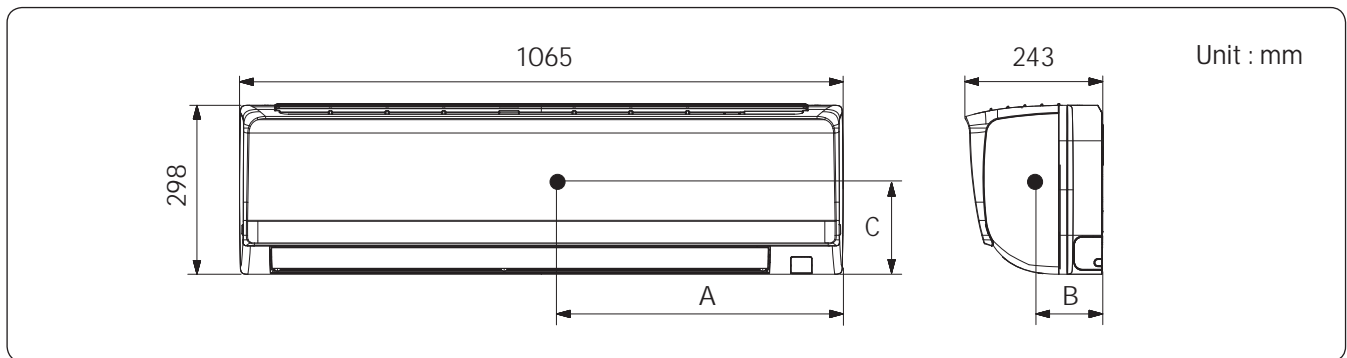

A	B	C
460	120	160

6. Electrical Wiring Diagram

BORACAY

AM***KN*D****

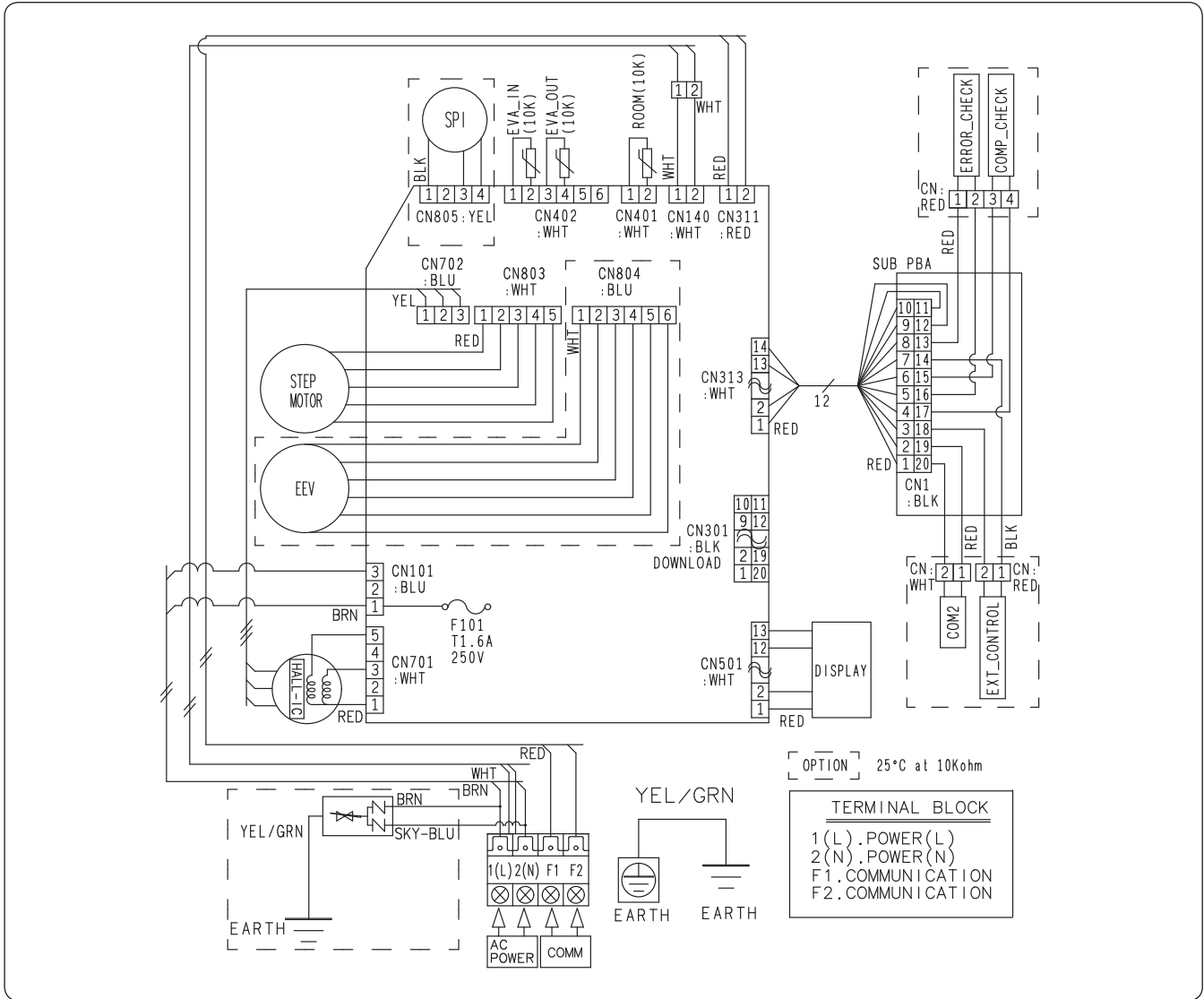

SUB PBA	Printed Circuit Board(SUB)	SPI	S-Plasma ion	EVA-OUT(10K)	Thermistor EVA OUT(10K)
[HALL IC]	Motor For FAN	ROOM(10K)	Thermistor ROOM In(10K)	EVA-IN(10K)	Thermistor EVA IN(10K)
EEV	electronic expansion valve				

NOTE

- This wiring diagram applies only to the Indoor unit.
- Symbols show as follow :
BLK: black, RED: red, BLU: blue, WHT: white, YEL: yellow, BRN: brown, sky: sky blue, GRN: green
- For connection wiring indoor-outdoor transmission F1-F2, indoor-wired remote controller transmission F3-F4.
- Protective earth(SCREW)

EARTH EARTH

7. Sound Data

BORACAY

Sound Pressure Level

Unit: dB(A)

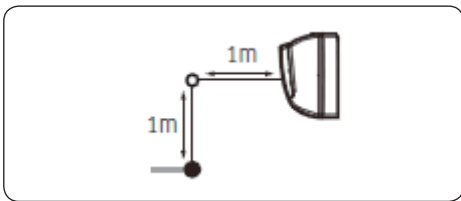

MODEL	Hi	MID	LOW
AM015KN*D*****	30	28	25
AM022KN*D*****	31	28	25
AM028KN*D*****	31	29	26
AM036KN*D*****	36	33	29

NR Curve

1) AM015KN*D*****

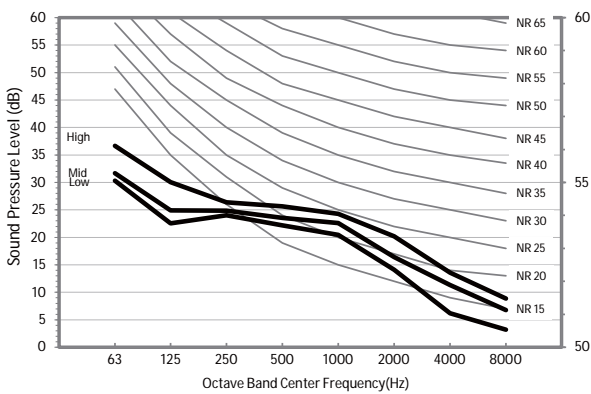

2) AM022KN*D*****

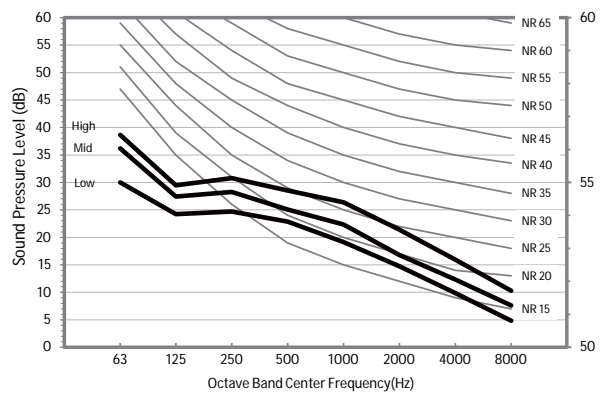

3) AM028KN*D*****

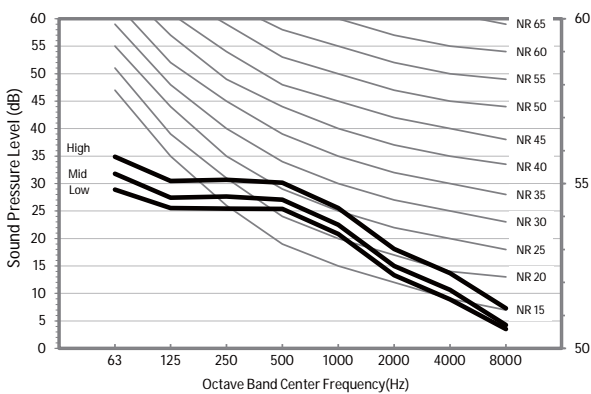

4) AM036KN*D*****

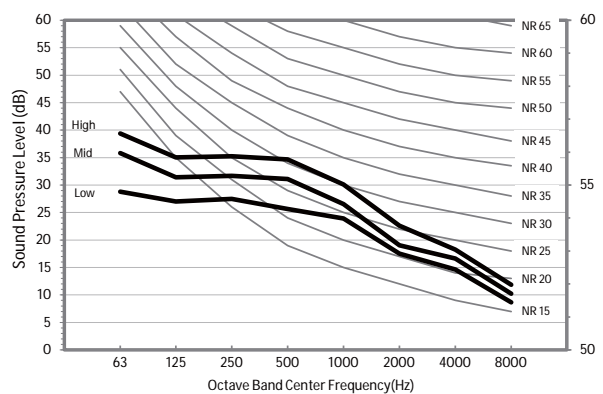

NOTE

- Specifications may be subject to change without prior notice
- Sound Pressure Level
 - Sound Pressure level is obtained in an anechoic room.
 - Sound Pressure level is a relative value, depending on the distance and acoustic environment.
 - Sound Pressure level may differ depending on operation condition.
 - dBA = A-weighted sound power level.
 - Reference acoustic pressure 0 dB = 20μPa

7. Sound Data

BORACAY

Sound Pressure Level

Unit: dB(A)

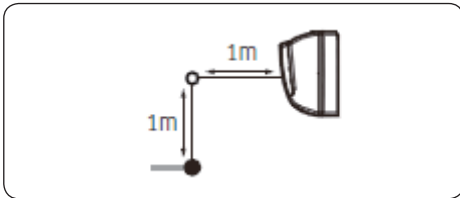

MODEL	Hi	MID	LOW
AM045KN*D*****	38	35	33
AM056KN*D*****	39	36	33
AM071KN*D*****	40	38	35

NR Curve

5) AM045KN*D*****

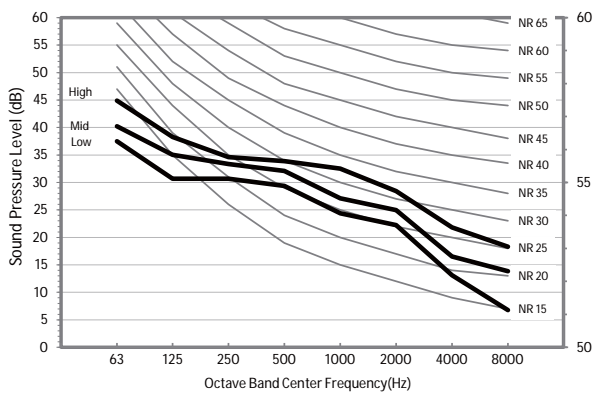

6) AM056KN*D*****

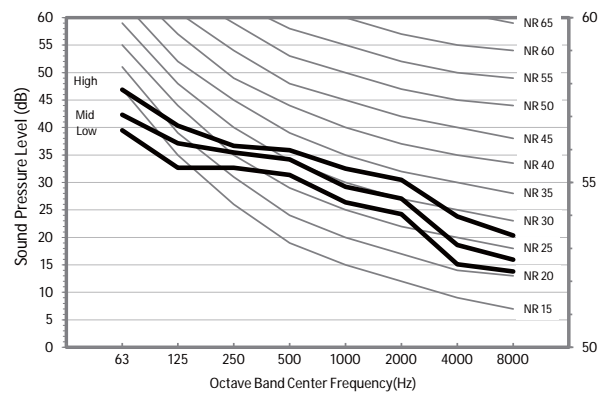

7) AM071KN*D*****

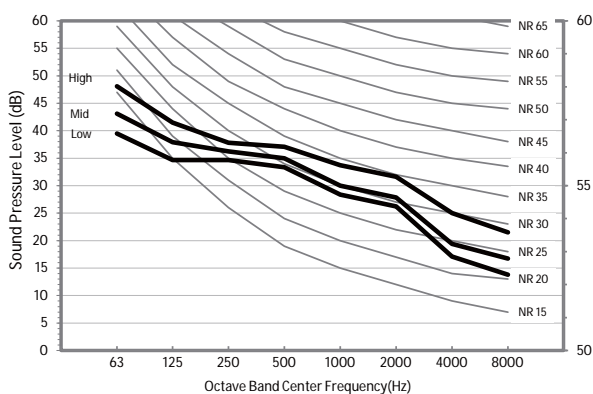

NOTE

- Specifications may be subject to change without prior notice
- Sound Pressure Level
 - Sound Pressure level is obtained in an anechoic room.
 - Sound Pressure level is a relative value, depending on the distance and acoustic environment.
 - Sound Pressure level may differ depending on operation condition.
 - dBA = A-weighted sound power level.
 - Reference acoustic pressure 0 dB = 20μPa

7. Sound Data

BORACAY

Sound Power Level

Unit: dB(A)

MODEL	Power
AM015KN*D*****	47
AM022KN*D*****	48
AM028KN*D*****	48
AM036KN*D*****	51

1) AM015KN*D*****

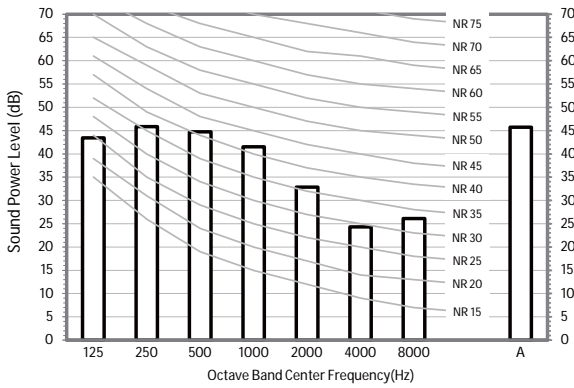

2) AM022KN*D*****

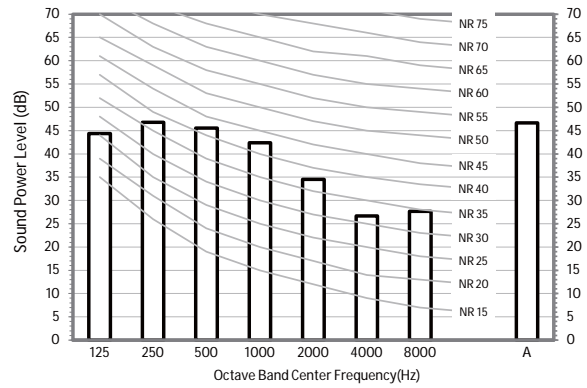

3) AM028KN*D*****

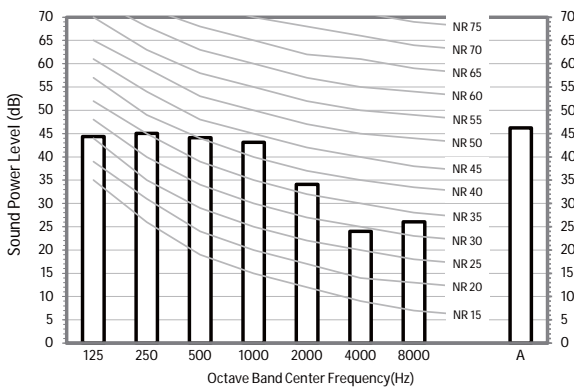

4) AM036KN*D*****

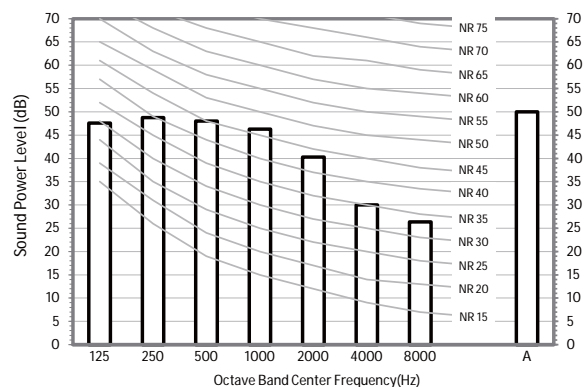

NOTE

- Specifications may be subject to change without prior notice.
 - Sound power level is an absolute value that a sound source generates.
 - dBA = A-weighted sound power level.
 - Reference power: 1pW.
 - Measured according to ISO 3741.

7. Sound Data

BORACAY

Sound Power Level

Unit: dB(A)

MODEL	Power
AM045KN*D*****	53
AM056KN*D*****	53
AM071KN*D*****	55

5) AM045KN*D*****

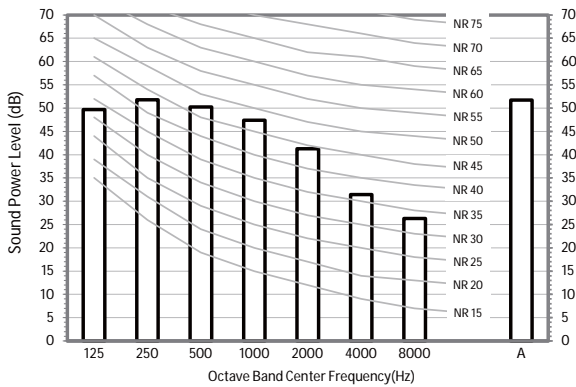

6) AM056KN*D*****

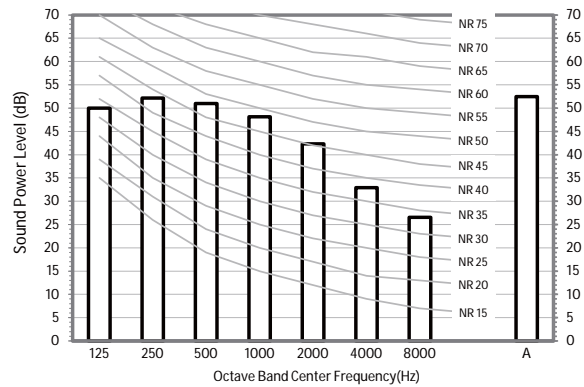

7) AM071KN*D*****

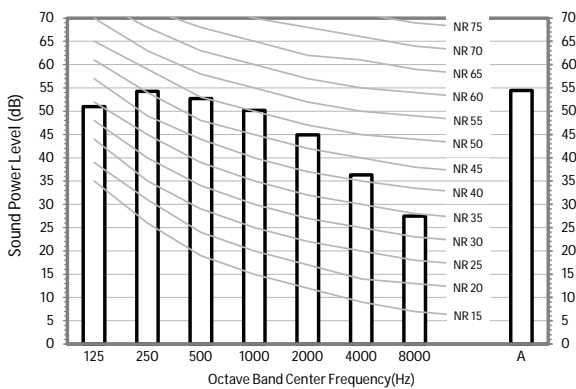

NOTE

- Specifications may be subject to change without prior notice.
 - Sound power level is an absolute value that a sound source generates.
 - dBA = A-weighted sound power level.
 - Reference power: 1pW.
 - Measured according to ISO 3741.

8. Temperature and Air Flow Distribution

BORACAY

AM015KN*D*****

Discharge angle : 26°

1) Cooling air velocity distribution

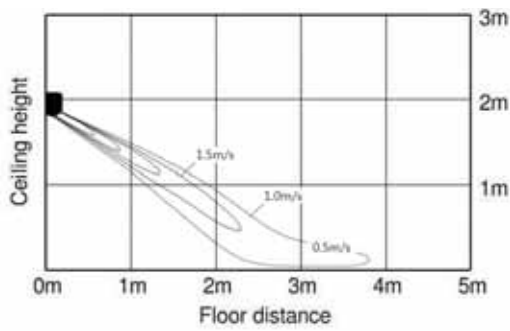

2) Cooling temperature distribution

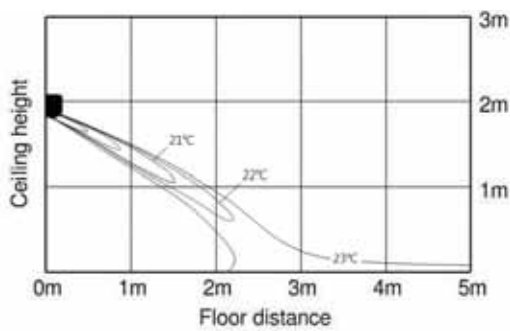

3) Heating air velocity distribution

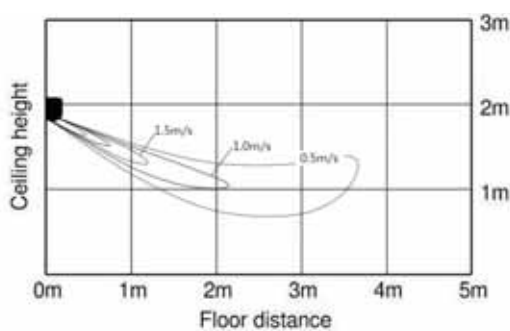

4) Heating temperature distribution

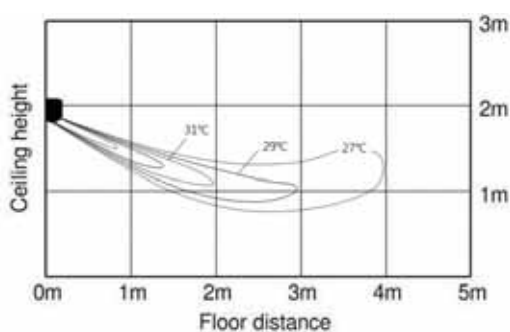

8. Temperature and Air Flow Distribution

BORACAY

AM022KN*D*****

Discharge angle : 26°

1) Cooling air velocity distribution

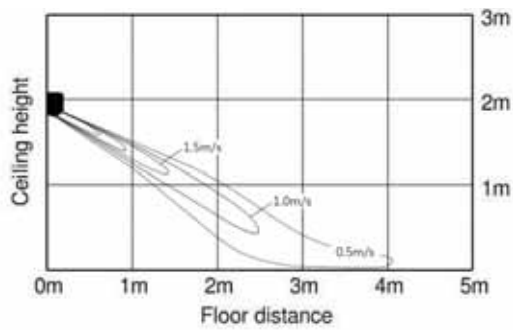

2) Cooling temperature distribution

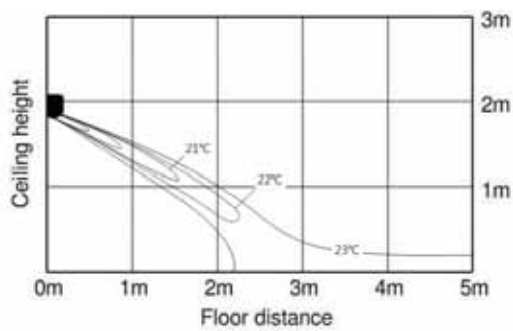

3) Heating air velocity distribution

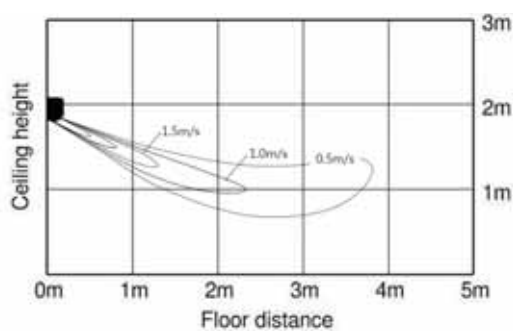

4) Heating temperature distribution

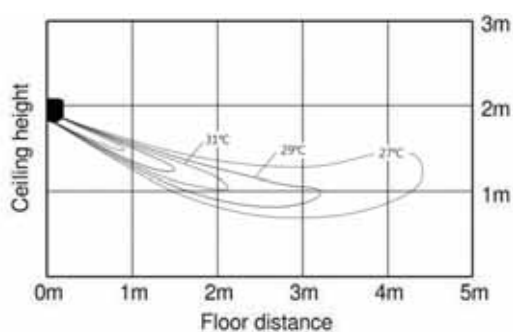

8. Temperature and Air Flow Distribution

BORACAY

AM028KN*D*****

Discharge angle : 26°

1) Cooling air velocity distribution

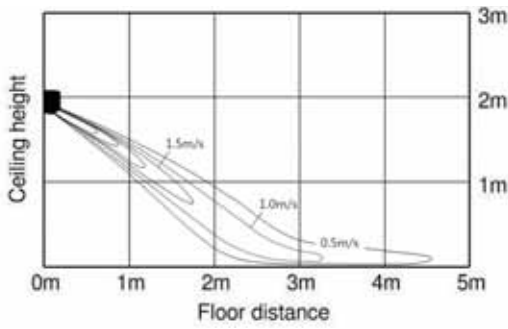

2) Cooling temperature distribution

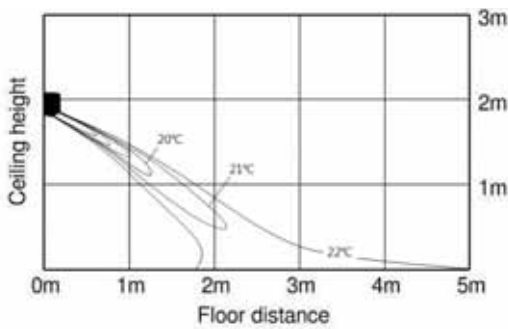

3) Heating air velocity distribution

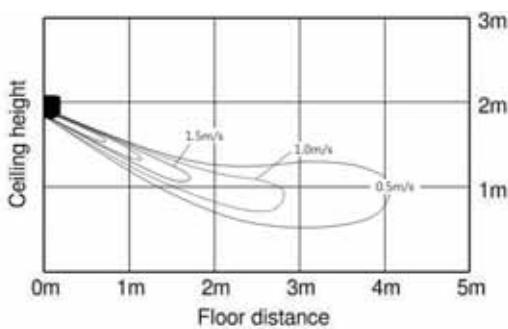

4) Heating temperature distribution

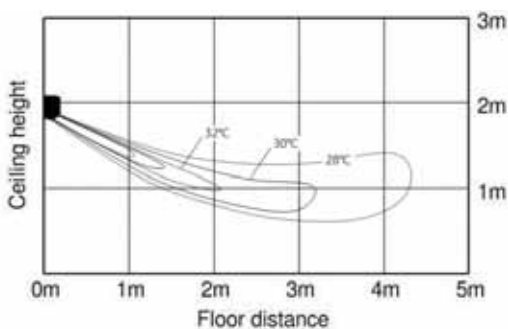

8. Temperature and Air Flow Distribution

BORACAY

AM036KN*D*****

Discharge angle : 26°

1) Cooling air velocity distribution

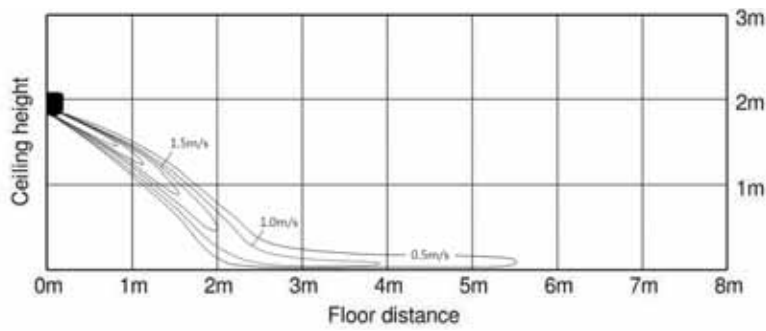

2) Cooling temperature distribution

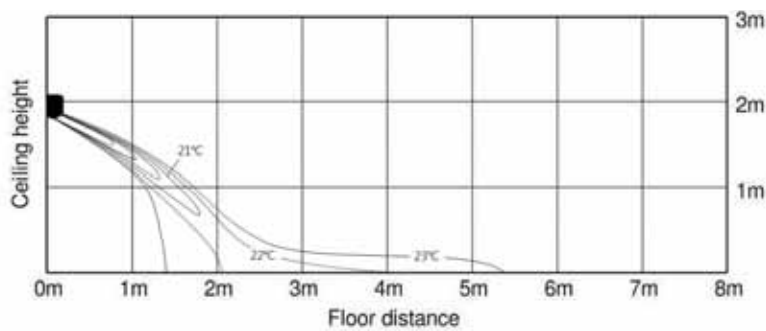

3) Heating air velocity distribution

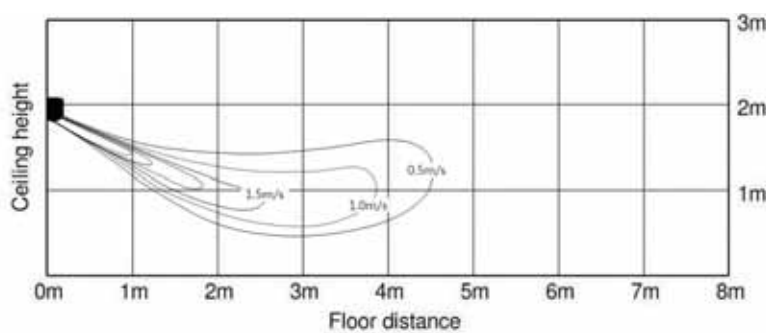

4) Heating temperature distribution

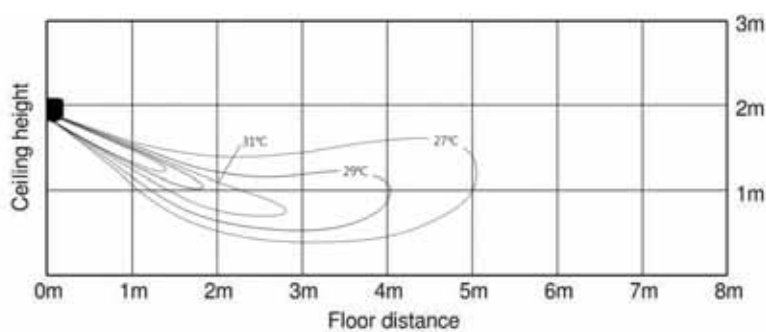

8. Temperature and Air Flow Distribution

BORACAY

AM045KN*D*****

Discharge angle : 26°

1) Cooling air velocity distribution

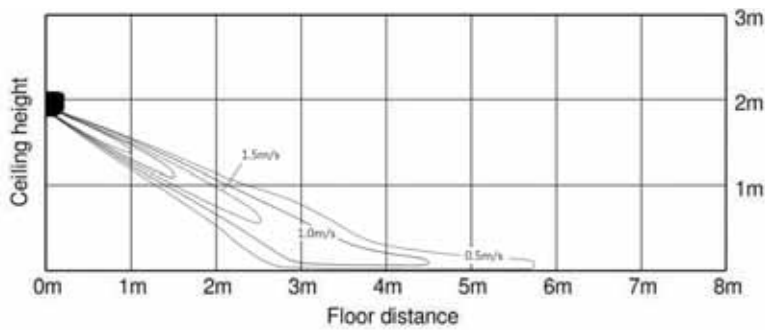

2) Cooling temperature distribution

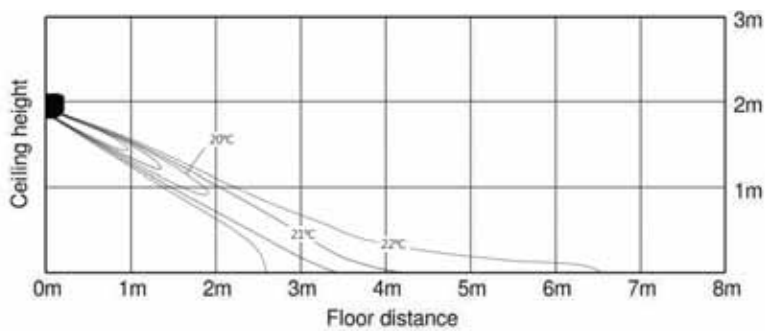

3) Heating air velocity distribution

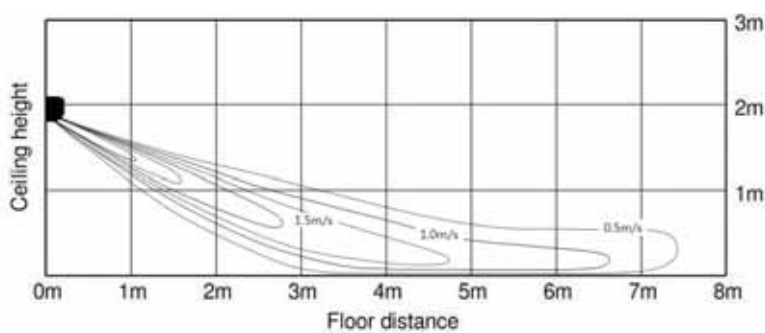

4) Heating temperature distribution

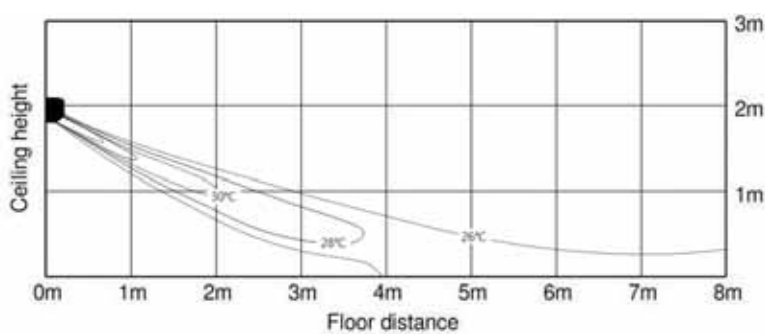

8. Temperature and Air Flow Distribution

BORACAY

AM056KN*D*****

Discharge angle : 26°

1) Cooling air velocity distribution

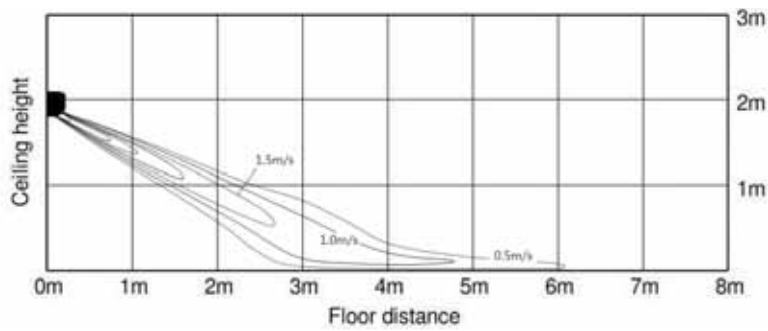

2) Cooling temperature distribution

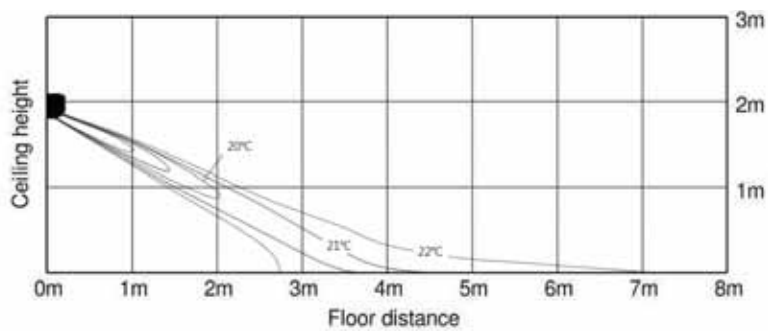

3) Heating air velocity distribution

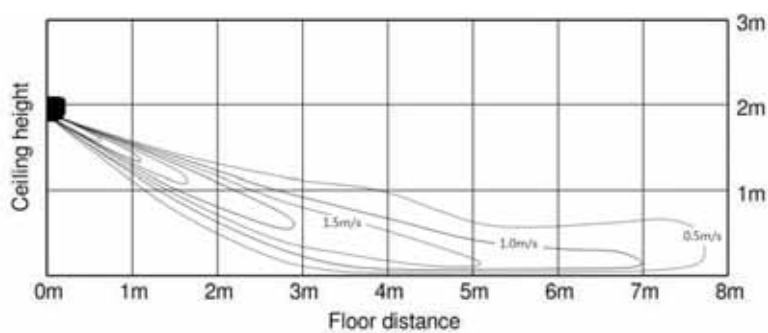

4) Heating temperature distribution

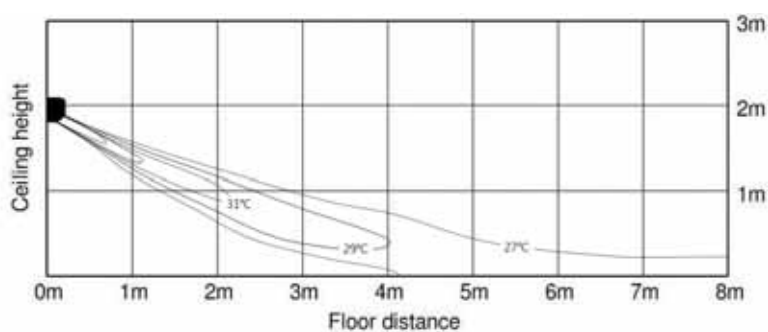

8. Temperature and Air Flow Distribution

BORACAY

AM071KN*D*****

Discharge angle : 26°

1) Cooling air velocity distribution

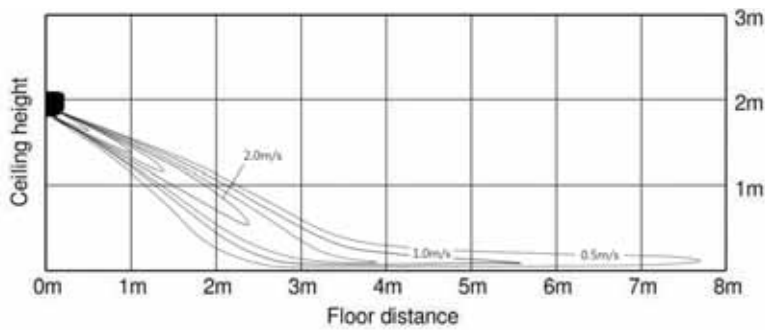

2) Cooling temperature distribution

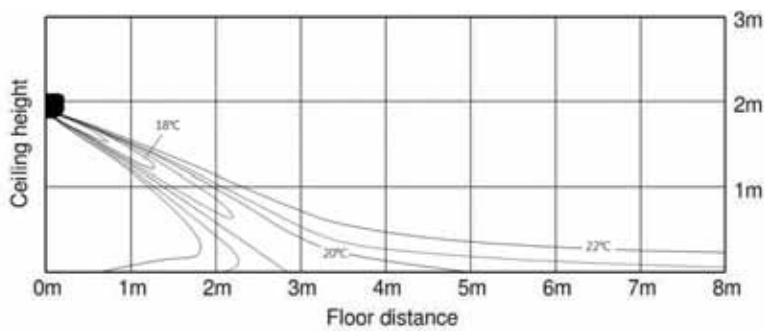

3) Heating air velocity distribution

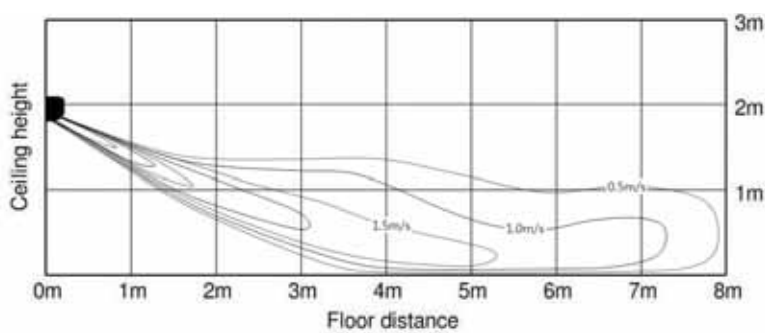

4) Heating temperature distribution

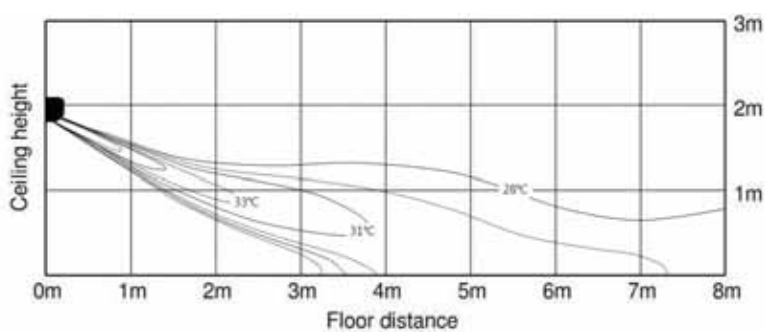

9. Piping Diagram

BORACAY

EEV included Model

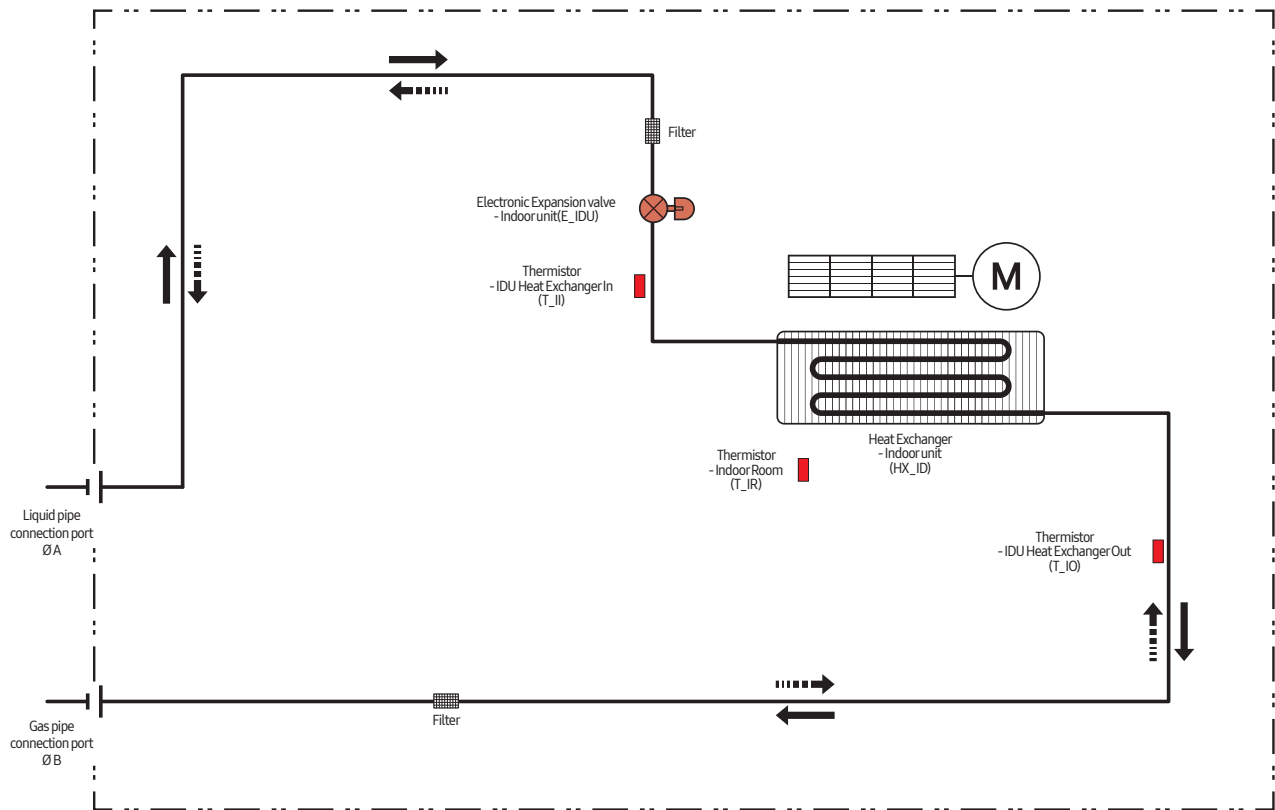

Refrigerant flow	
Cooling	Heating
→	⋯→

MODEL	A	B
AM015KNQD*****	6.35	12.7
AM022KNQD*****		
AM028KNQD*****		
AM036KNQD*****		
AM045KNQD*****		
AM056KNQD*****		
AM071KNQD*****	9.52	15.88

9. Piping Diagram

BORACAY

EEV not included Model

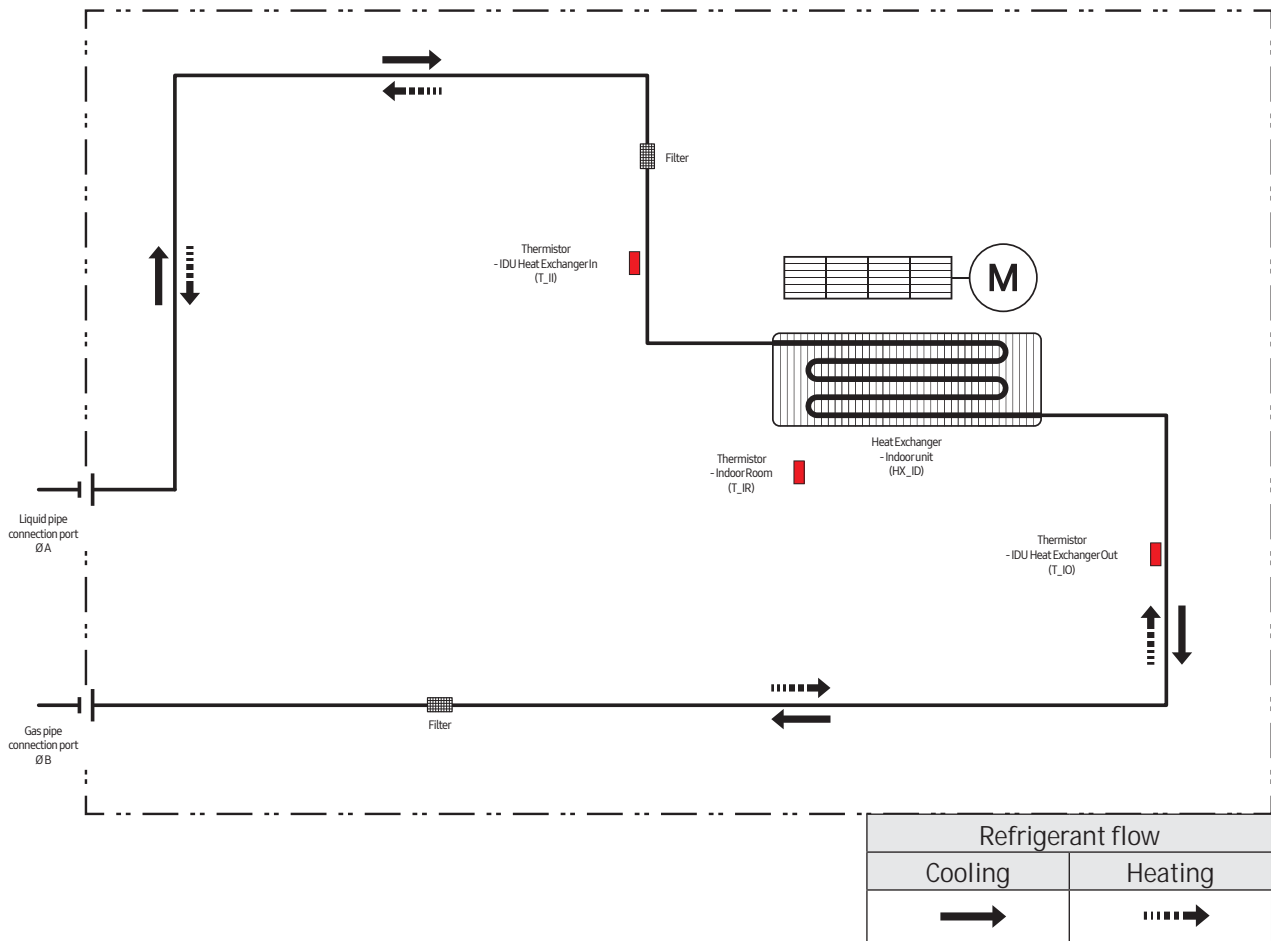

MODEL	A	B
AM015KNTD*****	6.35	12.7
AM022KNTD*****		
AM028KNTD*****		
AM036KNTD*****		
AM045KNTD*****		
AM056KNTD*****	9.52	15.88
AM071KNTD*****		